



SIRIUS soft starter 200-480 V 63 A, 24 V AC/DC Screw terminals
Thermistor input







product brand name	SIRIUS
product category	Hybrid switching devices
product designation	Soft starter
product type designation	3RW52
manufacturer's article number	<ul style="list-style-type: none"> • of standard HMI module usable 3RW5980-0HS00 • of high feature HMI module usable 3RW5980-0HF00 • of communication module PROFINET standard usable 3RW5980-0CS00 • of communication module PROFIBUS usable 3RW5980-0CP00 • of communication module Modbus TCP usable 3RW5980-0CT00 • of communication module Modbus RTU usable 3RW5980-0CR00 • of communication module Ethernet/IP 3RW5980-0CE00 • of circuit breaker usable at 400 V 3VA2163-7MN32-0AA0: Type of coordination 1, Iq = 65 kA, CLASS 10 • of circuit breaker usable at 500 V 3VA2163-7MN32-0AA0: Type of coordination 1, Iq = 20 kA, CLASS 10 • of circuit breaker usable at 400 V at inside-delta circuit 3VA2110-7MN32-0AA0: Type of coordination 1, Iq = 65 kA, CLASS 10 • of circuit breaker usable at 500 V at inside-delta circuit 3VA2110-7MN32-0AA0: Type of coordination 1, Iq = 20 kA, CLASS 10 • of the gG fuse usable up to 690 V 3NA3830-6: Type of coordination 1, Iq = 65 kA • of the gG fuse usable at inside-delta circuit up to 500 V 3NA3830-6: Type of coordination 1, Iq = 65 kA • of full range R fuse link for semiconductor protection usable up to 690 V 3NE1022-0: Type of coordination 2, Iq = 65 kA • of back-up R fuse link for semiconductor protection usable up to 690 V 3NE8024-1: Type of coordination 2, Iq = 65 kA
General technical data	
starting voltage [%]	30 ... 100 %
stopping voltage [%]	50 ... 50 %
start-up ramp time of soft starter	0 ... 20 s
current limiting value [%] adjustable	130 ... 700 %
certificate of suitability	<ul style="list-style-type: none"> • CE marking Yes • UL approval Yes • CSA approval Yes
product component is supported	<ul style="list-style-type: none"> • HMI-Standard Yes • HMI-High Feature Yes
product feature integrated bypass contact system	Yes
number of controlled phases	3
trip class	CLASS 10A (default) / 10E / 20E; acc. to IEC 60947-4-2

buffering time in the event of power failure	
• for main current circuit	100 ms
• for control circuit	100 ms
insulation voltage rated value	600 V
degree of pollution	3, acc. to IEC 60947-4-2
impulse voltage rated value	6 kV
blocking voltage of the thyristor maximum	1 400 V
service factor	1
surge voltage resistance rated value	6 kV
maximum permissible voltage for safe isolation	
• between main and auxiliary circuit	600 V
shock resistance	15 g / 11 ms, from 12 g / 11 ms with potential contact lifting
vibration resistance	15 mm to 6 Hz; 2g to 500 Hz
utilization category acc. to IEC 60947-4-2	AC 53a
reference code acc. to IEC 81346-2	Q
Substance Prohibitance (Date)	15.02.2018 00:00:00
product function	
• ramp-up (soft starting)	Yes
• ramp-down (soft stop)	Yes
• Soft Torque	Yes
• adjustable current limitation	Yes
• pump ramp down	Yes
• intrinsic device protection	Yes
• motor overload protection	Yes; Full motor protection (thermistor motor protection and electronic motor overload protection)
• evaluation of thermistor motor protection	Yes; Type A PTC or Klixon / Thermoclick
• inside-delta circuit	Yes
• auto-RESET	Yes
• manual RESET	Yes
• remote reset	Yes; By turning off the control supply voltage
• communication function	Yes
• operating measured value display	Yes; Only in conjunction with special accessories
• error logbook	Yes; Only in conjunction with special accessories
• via software parameterizable	No
• via software configurable	Yes
• PROFInergy	Yes; in connection with the PROFINET Standard communication module
• firmware update	Yes
• removable terminal for control circuit	Yes
• torque control	No
• analog output	No
Power Electronics	
operational current	
• at 40 °C rated value	63 A
• at 50 °C rated value	56 A
• at 60 °C rated value	51 A
operational current at inside-delta circuit	
• at 40 °C rated value	109 A
• at 50 °C rated value	96 A
• at 60 °C rated value	87.5 A
operating voltage	
• rated value	200 ... 480 V
• at inside-delta circuit rated value	200 ... 480 V
relative negative tolerance of the operating voltage	-15 %
relative positive tolerance of the operating voltage	10 %
relative negative tolerance of the operating voltage at inside-delta circuit	-15 %
relative positive tolerance of the operating voltage at inside-delta circuit	10 %
operating power for 3-phase motors	
• at 230 V at 40 °C rated value	18.5 kW

<ul style="list-style-type: none"> • at 230 V at inside-delta circuit at 40 °C rated value 	30 kW
<ul style="list-style-type: none"> • at 400 V at 40 °C rated value 	30 kW
<ul style="list-style-type: none"> • at 400 V at inside-delta circuit at 40 °C rated value 	55 kW
Operating frequency 1 rated value	50 Hz
Operating frequency 2 rated value	60 Hz
relative negative tolerance of the operating frequency	-10 %
relative positive tolerance of the operating frequency	10 %
adjustable motor current	
<ul style="list-style-type: none"> • at rotary coding switch on switch position 1 	25.5 A
<ul style="list-style-type: none"> • at rotary coding switch on switch position 2 	28 A
<ul style="list-style-type: none"> • at rotary coding switch on switch position 3 	30.5 A
<ul style="list-style-type: none"> • at rotary coding switch on switch position 4 	33 A
<ul style="list-style-type: none"> • at rotary coding switch on switch position 5 	35.5 A
<ul style="list-style-type: none"> • at rotary coding switch on switch position 6 	38 A
<ul style="list-style-type: none"> • at rotary coding switch on switch position 7 	40.5 A
<ul style="list-style-type: none"> • at rotary coding switch on switch position 8 	43 A
<ul style="list-style-type: none"> • at rotary coding switch on switch position 9 	45.5 A
<ul style="list-style-type: none"> • at rotary coding switch on switch position 10 	48 A
<ul style="list-style-type: none"> • at rotary coding switch on switch position 11 	50.5 A
<ul style="list-style-type: none"> • at rotary coding switch on switch position 12 	53 A
<ul style="list-style-type: none"> • at rotary coding switch on switch position 13 	55.5 A
<ul style="list-style-type: none"> • at rotary coding switch on switch position 14 	58 A
<ul style="list-style-type: none"> • at rotary coding switch on switch position 15 	60.5 A
<ul style="list-style-type: none"> • at rotary coding switch on switch position 16 	63 A
<ul style="list-style-type: none"> • minimum 	25.5 A
adjustable motor current	
<ul style="list-style-type: none"> • for inside-delta circuit at rotary coding switch on switch position 1 	44.2 A
<ul style="list-style-type: none"> • for inside-delta circuit at rotary coding switch on switch position 2 	48.5 A
<ul style="list-style-type: none"> • for inside-delta circuit at rotary coding switch on switch position 3 	52.8 A
<ul style="list-style-type: none"> • for inside-delta circuit at rotary coding switch on switch position 4 	57.2 A
<ul style="list-style-type: none"> • for inside-delta circuit at rotary coding switch on switch position 5 	61.5 A
<ul style="list-style-type: none"> • for inside-delta circuit at rotary coding switch on switch position 6 	65.8 A
<ul style="list-style-type: none"> • for inside-delta circuit at rotary coding switch on switch position 7 	70.1 A
<ul style="list-style-type: none"> • for inside-delta circuit at rotary coding switch on switch position 8 	74.5 A
<ul style="list-style-type: none"> • for inside-delta circuit at rotary coding switch on switch position 9 	78.8 A
<ul style="list-style-type: none"> • for inside-delta circuit at rotary coding switch on switch position 10 	83.1 A
<ul style="list-style-type: none"> • for inside-delta circuit at rotary coding switch on switch position 11 	87.5 A
<ul style="list-style-type: none"> • for inside-delta circuit at rotary coding switch on switch position 12 	91.8 A
<ul style="list-style-type: none"> • for inside-delta circuit at rotary coding switch on switch position 13 	96.1 A
<ul style="list-style-type: none"> • for inside-delta circuit at rotary coding switch on switch position 14 	100 A
<ul style="list-style-type: none"> • for inside-delta circuit at rotary coding switch on switch position 15 	105 A
<ul style="list-style-type: none"> • for inside-delta circuit at rotary coding switch on switch position 16 	109 A
<ul style="list-style-type: none"> • at inside-delta circuit minimum 	44.2 A
minimum load [%]	15 %; Relative to smallest settable le
power loss [W] for rated value of the current at AC	
<ul style="list-style-type: none"> • at 40 °C after startup 	31 W
<ul style="list-style-type: none"> • at 50 °C after startup 	29 W
<ul style="list-style-type: none"> • at 60 °C after startup 	27 W

power loss [W] at AC at current limitation 350 %	
• at 40 °C during startup	882 W
• at 50 °C during startup	744 W
• at 60 °C during startup	659 W
Control circuit/ Control	
type of voltage of the control supply voltage	AC/DC
control supply voltage at AC	
• at 50 Hz rated value	24 V
• at 60 Hz rated value	24 V
relative negative tolerance of the control supply voltage at AC at 50 Hz	-20 %
relative positive tolerance of the control supply voltage at AC at 50 Hz	20 %
relative negative tolerance of the control supply voltage at AC at 60 Hz	-20 %
relative positive tolerance of the control supply voltage at AC at 60 Hz	20 %
control supply voltage frequency	50 ... 60 Hz
relative negative tolerance of the control supply voltage frequency	-10 %
relative positive tolerance of the control supply voltage frequency	10 %
control supply voltage	
• at DC rated value	24 V
relative negative tolerance of the control supply voltage at DC	-20 %
relative positive tolerance of the control supply voltage at DC	20 %
control supply current in standby mode rated value	160 mA
holding current in bypass operation rated value	380 mA
locked-rotor current at close of bypass contact maximum	7.6 A
inrush current peak at application of control supply voltage maximum	3.3 A
duration of inrush current peak at application of control supply voltage	12.1 ms
design of the overvoltage protection	Varistor
design of short-circuit protection for control circuit	4 A gG fuse (I _{cu} =1 kA), 6 A quick-acting fuse (I _{cu} =1 kA), C1 miniature circuit breaker (I _{cu} = 600 A), C6 miniature circuit breaker (I _{cu} = 300 A); Is not part of scope of supply
Inputs/ Outputs	
number of digital inputs	1
number of inputs for thermistor connection	1; Type A PTC or Klixon / Thermoclick
number of digital outputs	3
• not parameterizable	2
digital output version	2 normally-open contacts (NO) / 1 changeover contact (CO)
number of analog outputs	0
switching capacity current of the relay outputs	
• at AC-15 at 250 V rated value	3 A
• at DC-13 at 24 V rated value	1 A
Installation/ mounting/ dimensions	
mounting position	+/- 10° rotation possible and can be tilted forward or backward on vertical mounting surface
fastening method	screw fixing
height	306 mm
width	185 mm
depth	203 mm
required spacing with side-by-side mounting	
• forwards	10 mm
• backwards	0 mm
• upwards	100 mm
• downwards	75 mm
• at the side	5 mm

weight without packaging	5.6 kg
Connections/ Terminals	
type of electrical connection	
<ul style="list-style-type: none"> • for main current circuit • for control circuit 	box terminal screw-type terminals
width of connection bar maximum	25 mm
wire length for thermistor connection	
<ul style="list-style-type: none"> • with conductor cross-section = 0.5 mm² maximum • with conductor cross-section = 1.5 mm² maximum • with conductor cross-section = 2.5 mm² maximum 	50 m 150 m 250 m
type of connectable conductor cross-sections	
<ul style="list-style-type: none"> • for main contacts for box terminal using the front clamping point solid 	1x (2.5 ... 16 mm ²)
<ul style="list-style-type: none"> • for main contacts for box terminal using the front clamping point finely stranded with core end processing 	1x (2.5 ... 50 mm ²)
<ul style="list-style-type: none"> • for main contacts for box terminal using the front clamping point stranded 	1x (10 ... 70 mm ²)
<ul style="list-style-type: none"> • at AWG cables for main contacts for box terminal using the front clamping point 	1x (10 ... 2/0)
<ul style="list-style-type: none"> • for main contacts for box terminal using the back clamping point solid 	1x (2.5 ... 16 mm ²)
<ul style="list-style-type: none"> • at AWG cables for main contacts for box terminal using the back clamping point 	1x (10 ... 2/0)
<ul style="list-style-type: none"> • for main contacts for box terminal using both clamping points solid 	2x (2.5 ... 16 mm ²)
<ul style="list-style-type: none"> • for main contacts for box terminal using both clamping points finely stranded with core end processing 	2x (2.5 ... 35 mm ²)
<ul style="list-style-type: none"> • for main contacts for box terminal using both clamping points stranded 	2x (6 ... 16 mm ²), 2x (10 ... 50 mm ²)
<ul style="list-style-type: none"> • for main contacts for box terminal using the back clamping point finely stranded with core end processing 	1x (2.5 ... 50 mm ²)
<ul style="list-style-type: none"> • for main contacts for box terminal using the back clamping point stranded 	1x (10 ... 70 mm ²)
type of connectable conductor cross-sections	
<ul style="list-style-type: none"> • for control circuit solid 	1x (0.5 ... 4.0 mm ²), 2x (0.5 ... 2.5 mm ²)
<ul style="list-style-type: none"> • for control circuit finely stranded with core end processing 	1x (0.5 ... 2.5 mm ²), 2x (0.5 ... 1.5 mm ²)
<ul style="list-style-type: none"> • at AWG cables for control circuit solid 	1x (20 ... 12), 2x (20 ... 14)
wire length	
<ul style="list-style-type: none"> • between soft starter and motor maximum 	800 m
<ul style="list-style-type: none"> • at the digital inputs at AC maximum 	100 m
<ul style="list-style-type: none"> • at the digital inputs at DC maximum 	1 000 m
tightening torque	
<ul style="list-style-type: none"> • for main contacts with screw-type terminals 	4.5 ... 6 N·m
<ul style="list-style-type: none"> • for auxiliary and control contacts with screw-type terminals 	0.8 ... 1.2 N·m
tightening torque [lbf·in]	
<ul style="list-style-type: none"> • for main contacts with screw-type terminals 	40 ... 53 lbf·in
<ul style="list-style-type: none"> • for auxiliary and control contacts with screw-type terminals 	7 ... 10.3 lbf·in
Ambient conditions	
installation altitude at height above sea level maximum	5 000 m; Derating as of 1000 m, see catalog
ambient temperature	
<ul style="list-style-type: none"> • during operation 	-25 ... +60 °C; Please observe derating at temperatures of 40 °C or above
<ul style="list-style-type: none"> • during storage and transport 	-40 ... +80 °C
environmental category	
<ul style="list-style-type: none"> • during operation acc. to IEC 60721 	3K6 (no ice formation, only occasional condensation), 3C3 (no salt mist), 3S2 (sand must not get into the devices), 3M6
<ul style="list-style-type: none"> • during storage acc. to IEC 60721 	1K6 (only occasional condensation), 1C2 (no salt mist), 1S2 (sand must not get inside the devices), 1M4
<ul style="list-style-type: none"> • during transport acc. to IEC 60721 	2K2, 2C1, 2S1, 2M2 (max. fall height 0.3 m)

EMC emitted interference	acc. to IEC 60947-4-2: Class A	
Communication/ Protocol		
communication module is supported		
<ul style="list-style-type: none"> • PROFINET standard • EtherNet/IP • Modbus RTU • Modbus TCP • PROFIBUS 	Yes	Yes
	Yes	Yes
	Yes	Yes
	Yes	Yes
	Yes	Yes
UL/CSA ratings		
manufacturer's article number		
<ul style="list-style-type: none"> • of circuit breaker <ul style="list-style-type: none"> — usable for Standard Faults at 460/480 V according to UL — usable for High Faults at 460/480 V according to UL — usable for Standard Faults at 460/480 V at inside-delta circuit according to UL — usable for High Faults at 460/480 V at inside-delta circuit according to UL — usable for Standard Faults at 575/600 V according to UL — usable for Standard Faults at 575/600 V at inside-delta circuit according to UL • of the fuse <ul style="list-style-type: none"> — usable for Standard Faults up to 575/600 V according to UL — usable for High Faults up to 575/600 V according to UL — usable for Standard Faults at inside-delta circuit up to 575/600 V according to UL — usable for High Faults at inside-delta circuit up to 575/600 V according to UL 	Siemens type: 3RV2742, max. 70 A or 3VA51, max. 125 A; Iq = 10 kA	Siemens type: 3VA51, max. 125 A; Iq max = 65 kA
	Siemens type: 3VA51, max. 125 A; Iq = 10 kA	Siemens type: 3VA51, max. 125 A; Iq max = 65 kA
	Siemens type: 3RV2742, max. 70 A or 3VA51, max. 125 A; Iq = 10 kA	Siemens type: 3VA51, max. 125 A; Iq = 10 kA
	Siemens type: 3VA51, max. 125 A; Iq = 10 kA	
	Type: Class RK5 / K5, max. 200 A; Iq = 10 kA	Type: Class J / L, max. 225 A; Iq = 100 kA
	Type: Class J / L, max. 225 A; Iq = 100 kA	Type: Class RK5 / K5, max. 200 A; Iq = 10 kA
	Type: Class J / L, max. 225 A; Iq = 100 kA	Type: Class J / L, max. 225 A; Iq = 100 kA
operating power [hp] for 3-phase motors		
<ul style="list-style-type: none"> • at 200/208 V at 50 °C rated value • at 220/230 V at 50 °C rated value • at 460/480 V at 50 °C rated value • at 200/208 V at inside-delta circuit at 50 °C rated value • at 220/230 V at inside-delta circuit at 50 °C rated value • at 460/480 V at inside-delta circuit at 50 °C rated value 	15 hp	20 hp
	20 hp	40 hp
	30 hp	30 hp
	30 hp	75 hp
	75 hp	
contact rating of auxiliary contacts according to UL	R300-B300	
Safety related data		
protection class IP on the front acc. to IEC 60529	IP00; IP20 with cover	
touch protection on the front acc. to IEC 60529	finger-safe, for vertical contact from the front with cover	
electromagnetic compatibility	in accordance with IEC 60947-4-2	
Certificates/ approvals		
General Product Approval	EMC	Declaration of Conformity
     		
Test Certificates	Marine / Shipping	



other

[Confirmation](#)

Further information

Information- and Downloadcenter (Catalogs, Brochures,...)

<https://www.siemens.com/ic10>

Industry Mall (Online ordering system)

<https://mall.industry.siemens.com/mall/en/en/Catalog/product?mlfb=3RW5225-1TC04>

Cax online generator

<http://support.automation.siemens.com/WW/CAXorder/default.aspx?lang=en&mlfb=3RW5225-1TC04>

Service&Support (Manuals, Certificates, Characteristics, FAQs,...)

<https://support.industry.siemens.com/cs/ww/en/ps/3RW5225-1TC04>

Image database (product images, 2D dimension drawings, 3D models, device circuit diagrams, EPLAN macros, ...)

http://www.automation.siemens.com/bilddb/cax_de.aspx?mlfb=3RW5225-1TC04&lang=en

Characteristic: Tripping characteristics, I²t, Let-through current

<https://support.industry.siemens.com/cs/ww/en/ps/3RW5225-1TC04/char>

Characteristic: Installation altitude

<http://www.automation.siemens.com/bilddb/index.aspx?view=Search&mlfb=3RW5225-1TC04&objecttype=14&gridview=view1>

Simulation Tool for Soft Starters (STS)

<https://support.industry.siemens.com/cs/ww/en/view/101494917>

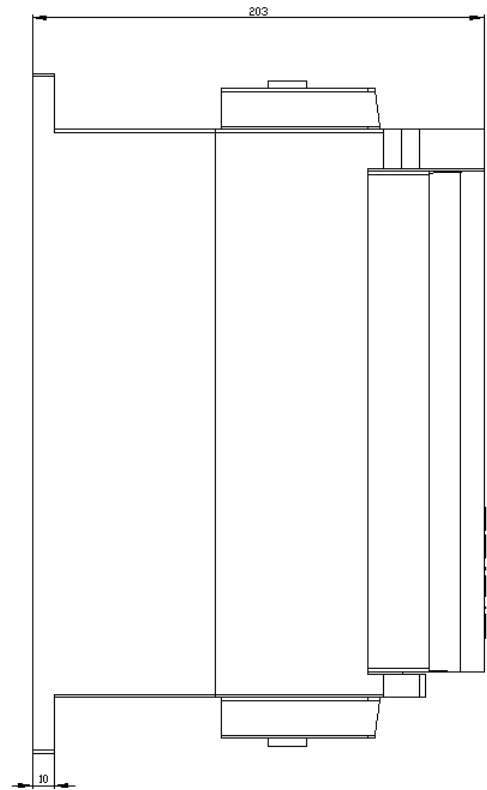
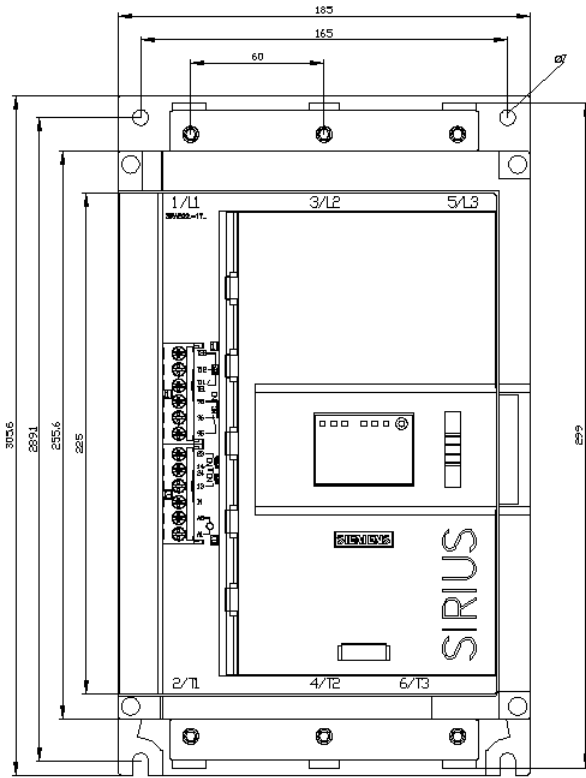

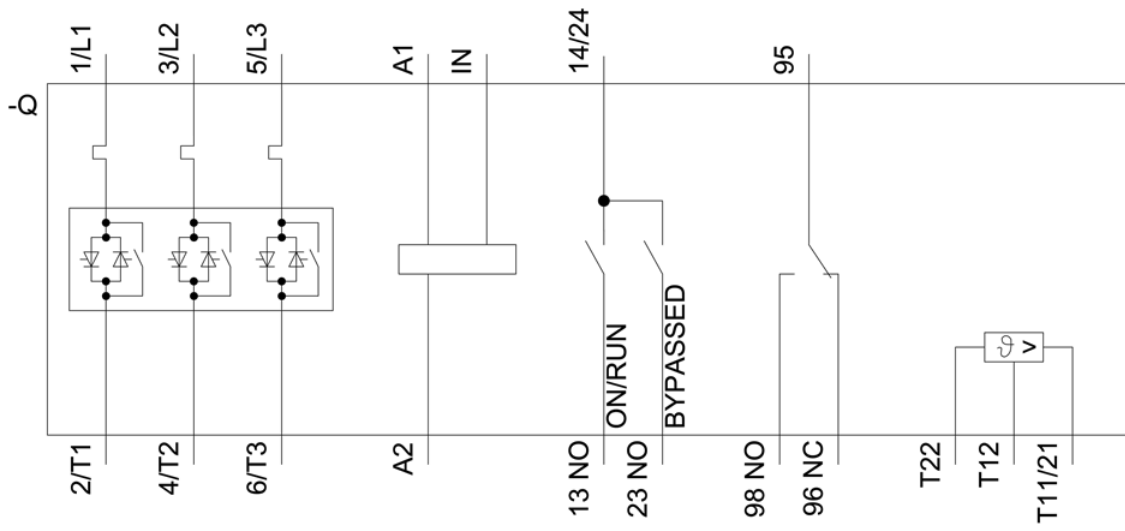

last modified:

8/10/2021 

