











Current/voltage measuring module V2; Set current 20...200 A, Voltage measurement up to 690 V, Overall width 120 mm, Busbar connection basic unit required pro V PB, pro V MR, pro V PN or pro V EIP



product brand name	SIRIUS
product designation	Current/voltage measuring module
General technical data	
product function	
<ul style="list-style-type: none"> • current measurement • voltage measurement • active power measurement • power measurement • frequency measurement 	<p>Yes</p> <p>Yes</p> <p>Yes</p> <p>Yes</p> <p>Yes</p>
measuring procedure for current measurement	TRMS
current measuring range extension with external current transformers	No
measuring procedure for voltage measurement	TRMS
measurable supply voltage between the line conductors at AC maximum rated value	690 V
line conductors and neutral conductors internal resistance for voltage measurement	1 MΩ; RC-based voltage divider
product component	
<ul style="list-style-type: none"> • input for thermistor connection 	No
insulation voltage	
<ul style="list-style-type: none"> • with degree of pollution 3 at AC rated value • for wires of main circuit acc. to IEC 60947-1 rated value 	<p>690 V</p> <p>6 kV</p>
surge voltage resistance rated value	6 000 V
protection class IP	IP00
shock resistance acc. to IEC 60068-2-27	15g / 11 ms; with basic unit snapped on
vibration resistance	1-6 Hz / 15 mm; 6-500 Hz / 2 g; with basic unit snapped on: 1g
reference code acc. to IEC 81346-2	F
Substance Prohibitance (Date)	28.05.2009 00:00:00
certificate of suitability	
<ul style="list-style-type: none"> • according to ATEX directive 2014/34/EU 	BVS 06 ATEX F001
explosion device group and category according to ATEX directive 2014/34/EU	II (2) G, II (2) D, I (M2)
Electromagnetic compatibility	
EMC emitted interference acc. to IEC 60947-1	class A
EMC immunity acc. to IEC 60947-1	corresponds to degree of severity 3
conducted interference	
<ul style="list-style-type: none"> • due to burst acc. to IEC 61000-4-4 • due to conductor-earth surge acc. to IEC 61000-4-5 • due to conductor-conductor surge acc. to IEC 61000-4-5 	<p>2 kV</p> <p>2 kV</p> <p>1 kV</p>

field-based interference acc. to IEC 61000-4-3	10 V/m
Inputs/ Outputs	
number of outputs as contact-affected switching element	0
Protective and monitoring functions	
product function	
<ul style="list-style-type: none"> • power factor monitoring 	Yes
<ul style="list-style-type: none"> • ground-fault monitoring 	Yes
<ul style="list-style-type: none"> • voltage detection 	Yes
product function	
<ul style="list-style-type: none"> • current detection 	Yes
<ul style="list-style-type: none"> • overload protection 	Yes
Precision	
measuring precision	
<ul style="list-style-type: none"> • of frequency measurement 	+/- 1,5 %, 15 A ... 1600 A, 0,85 x 110 V ... 1,1 x 690 V (line-to-line voltages), cos phi (0.5...1), 50/60 Hz, 25 °C
<ul style="list-style-type: none"> • for current measurement 1 	+/- 1,5 %, in range 15 A ... 400 A, in range 0,85 x 110 V ... 1,1 x 690 V (line-to-line voltages), 50/60 Hz, 25 °C
<ul style="list-style-type: none"> • for current measurement 2 	+/- 5 %, in range 400 A ... 1600 A, in range 0,85 x 110 V ... 1,1 x 690 V (line-to-line voltages), 50/60 Hz, 25 °C
<ul style="list-style-type: none"> • for voltage measurement 1 	+/- 1,5 %, in range 0,85 x 110 V ... 1,1 x 690 V (line-to-line voltages), 50/60 Hz, 25 °C
<ul style="list-style-type: none"> • at cos phi-measurement 1 	+/- 1,5 %, 15 A ... 400 A, 0,85 x 110 V ... 1,1 x 690 V (line-to-line voltages), cos phi (0.5...1), 50/60 Hz, 25 °C
<ul style="list-style-type: none"> • at cos phi-measurement 2 	+/- 5 %, 400 A ... 1600 A, 0,85 x 110 V ... 1,1 x 690 V (line-to-line voltages), cos phi (0.5...1), 50/60 Hz, 25 °C
<ul style="list-style-type: none"> • at active power measurement 1 	+/- 5 %, 15 A ... 400 A, 0,85 x 110 V ... 1,1 x 690 V (line-to-line voltages), cos-phi (0.5...1), 50/60 Hz, 25 °C
<ul style="list-style-type: none"> • at active power measurement 2 	+/- 10 %, 400 A ... 1600 A, 0,85 x 110 V ... 1,1 x 690 V (line-to-line voltages), cos phi (0.5...1), 50/60 Hz, 25 °C
<ul style="list-style-type: none"> • at energy measurement 1 	+/- 5 %, 47 ... 1260 A, 0,85 x 110 V ... 1,1 x 690 V (line-to-line voltages), cos phi (0.5...1), 50/60 Hz, 25 °C
<ul style="list-style-type: none"> • at energy measurement 2 	+/- 10 %, 400 A ... 1600 A, 0,85 x 110 V ... 1,1 x 690 V (line-to-line voltages), cos phi (0.5...1), 50/60 Hz, 25 °C
<ul style="list-style-type: none"> • at apparent power measurement 1 	+/- 3 %, 15 A ... 400 A, 0,85 x 110 V ... 1,1 x 690 V (line-to-line voltages), cos-phi (0.5...1), 50/60 Hz, 25 °C
<ul style="list-style-type: none"> • at apparent power measurement 2 	+/- 5 %, 400 A ... 1600 A, 0,85 x 110 V ... 1,1 x 690 V (line-to-line voltages), cos phi (0.5...1), 50/60 Hz, 25 °C
accuracy of ground-fault monitoring	In the range 30 % .. 120 %/Is: +/- 10 % (Class CI-A), in range 15 % .. 30 % Ie: +/- 25 % (Class CI-B), both values acc. to IEC 60947-1 Annex T
temperature drift per °C	0.01 %/°C; Reference temperature: 25°C
measured variable frequency	45 ... 65 Hz
Installation/ mounting/ dimensions	
mounting position	any
fastening method	direct mounting / stand-alone installation
height	119 mm
width	120 mm
depth	145 mm
required spacing	
<ul style="list-style-type: none"> • top 	30 mm
<ul style="list-style-type: none"> • bottom 	30 mm
<ul style="list-style-type: none"> • left 	0 mm
<ul style="list-style-type: none"> • right 	0 mm
Connections/ Terminals	
type of electrical connection at the measurement inputs for voltage	screw-type terminals
type of connectable conductor cross-sections at the measurement inputs for voltage	
<ul style="list-style-type: none"> • finely stranded with core end processing 	1x (0.5 ... 2.5 mm ²), 2x (0.5 ... 1.5 mm ²)
<ul style="list-style-type: none"> • solid 	1x (0.5 ... 4 mm ²), 2x (0.5 ... 2.5 mm ²)
<ul style="list-style-type: none"> • at AWG cables solid 	1x (20 ... 12), 2x (20 ... 14)
<ul style="list-style-type: none"> • at AWG cables stranded 	1x (20 ... 14), 2x (20 ... 16)
tightening torque at the measurement inputs for	0.8 ... 1.2 N·m

voltage					
tightening torque [lbf·in] at the measurement inputs for voltage	7 ... 10.3 lbf·in				
type of connectable conductor cross-sections at the measurement inputs for current	<ul style="list-style-type: none"> • solid with core end processing • stranded with core end processing • at AWG cables 				
design of the thread of the connection screw at the measurement inputs for current	M8 x 25				
Ambient conditions					
installation altitude at height above sea level	<ul style="list-style-type: none"> • 1 maximum • 2 maximum • 3 maximum 				
ambient temperature	<ul style="list-style-type: none"> • during operation • during storage • during transport 				
environmental category	<ul style="list-style-type: none"> • during operation acc. to IEC 60721 • during storage acc. to IEC 60721 • during transport acc. to IEC 60721 				
relative humidity during operation	10 ... 95 %				
Short-circuit protection					
product function short circuit protection	No				
Galvanic isolation					
(electrically) protective separation acc. to IEC 60947-1	All circuits with protective separation (double creepage paths and clearances), the information in the "Protective Separation" test report, No. A0258, must be observed (link see further information)				
Main circuit					
number of poles for main current circuit	3				
adjustable current response value current of the current-dependent overload release	20 ... 200 A				
operating voltage	<ul style="list-style-type: none"> • at AC — at 50 Hz rated value — at 60 Hz rated value 				
operating frequency rated value	50 ... 60 Hz				
Control circuit/ Control					
type of voltage	AC				
inrush current maximum	2 000 A; 10 x I _o				
Certificates/ approvals					
General Product Approval	EMC	For use in hazardous locations			
					
For use in hazardous locations		Declaration of Conformity	Test Certificates		
				Type Test Certificates/Test Report	Special Test Certificate

[Special Test Certificate](#)



[Confirmation](#)

other

[PROFINET-Certification](#)



Further information

Information- and Downloadcenter (Catalogs, Brochures,...)

<https://www.siemens.com/ic10>

Industry Mall (Online ordering system)

<https://mall.industry.siemens.com/mall/en/en/Catalog/product?mfb=3UF7113-1BA01-0>

Cax online generator

<http://support.automation.siemens.com/WW/CAXorder/default.aspx?lang=en&mfb=3UF7113-1BA01-0>

Service&Support (Manuals, Certificates, Characteristics, FAQs,...)

<https://support.industry.siemens.com/cs/ww/en/ps/3UF7113-1BA01-0>

Image database (product images, 2D dimension drawings, 3D models, device circuit diagrams, EPLAN macros, ...)

http://www.automation.siemens.com/bilddb/cax_de.aspx?mfb=3UF7113-1BA01-0&lang=en

Test report No. A0258, protective separation

<https://support.industry.siemens.com/cs/ww/en/view/109748152>

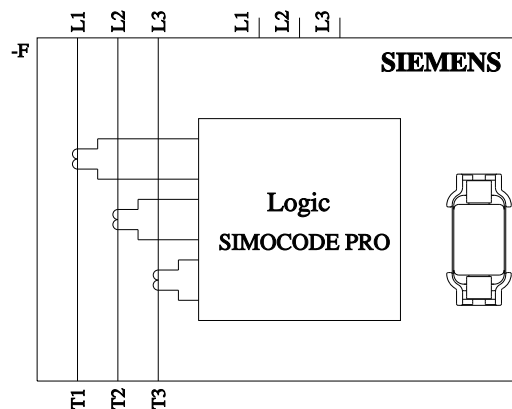
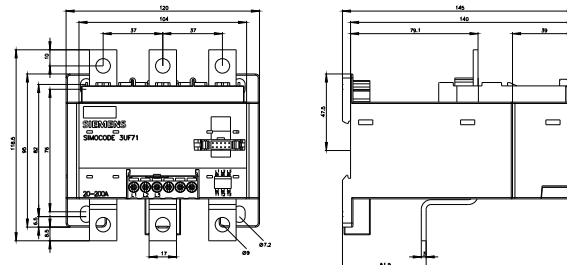

last modified:

1/18/2021