



residual current device RCD520 Basic RCD type A load side mounted rated resid. current 0.03...5A at 50/60Hz adjustable tv 0...3000ms 3-pole In=250A Ue=100-480V accessory for: 3VA1

Model	
product brand name	SETRON
product designation	Accessories
Product version	Residual current protection module type A
Product group primary device	3VA12
General technical data	
fastening method	screw fixing
number of poles	3
protection class IP / on the front	IP40
Current	
Current / at AC / rated value	250 A
response value / of the residual current	0.03;0.05;0.1;0.3;0.5;1;3;5
Mechanical Design	
product function / communication with residual current equipment	No
<ul style="list-style-type: none"> product function / integrated / alarm management product function / integrated / alarm management product function / remote-controlled tripping Fonctionnalité/plombable product function / selectable tripping characteristic product function / selectable RCD or monitoring mode 	Yes Pre-alarm indication 30% No Yes No No
remote reset function	No
position / of the infeed / on the RCD component	Top or bottom
type of electrical connection / for main current circuit	busbar connection
set values / of the limit value of not tripping time	0;0.06;0.15;0.3;0.5;1.0;2.0;3.0
type of trip indicator / electrical	Yes
type of trip indicator / communication	No
power loss [W] / maximum	21 W
Rated frequency	60 Hz
operating frequency	50/60Hz
Height	115 mm
Width	105 mm
depth	70 mm
net weight	1 242 g
ambient temperature / during operation <ul style="list-style-type: none"> minimum maximum 	-25 °C 70 °C

Further information

Information- and Downloadcenter (Catalogs, Brochures,...)

<http://www.siemens.com/lowvoltage/catalogs>

Industry Mall (Online ordering system)

<https://mall.industry.siemens.com/mall/en/en/Catalog/product?mfb=3VA9213-0RL20>

Service&Support (Manuals, Certificates, Characteristics, FAQs,...)

<https://support.industry.siemens.com/cs/ww/en/ps/3VA9213-0RL20>

Image database (product images, 2D dimension drawings, 3D models, device circuit diagrams, ...)

http://www.automation.siemens.com/bilddb/cax_en.aspx?mfb=3VA9213-0RL20

CAX-Online-Generator

<http://www.siemens.com/cax>

Tender specifications

<http://www.siemens.com/specifications>

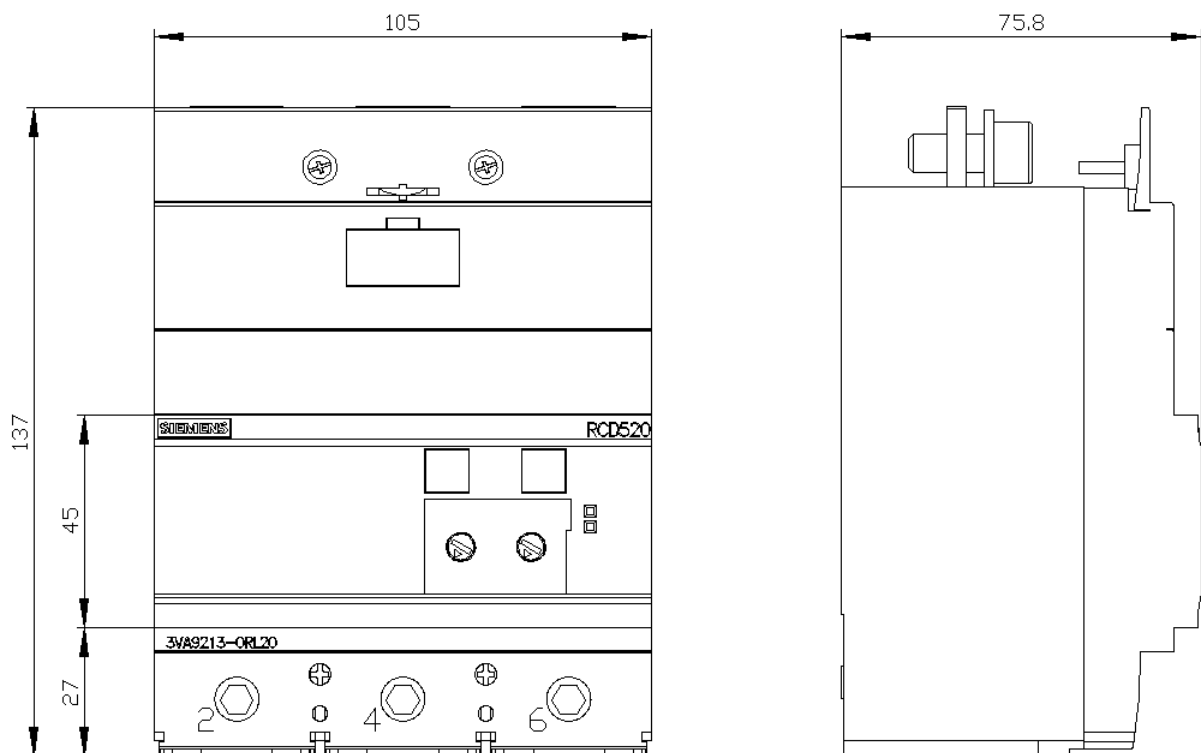

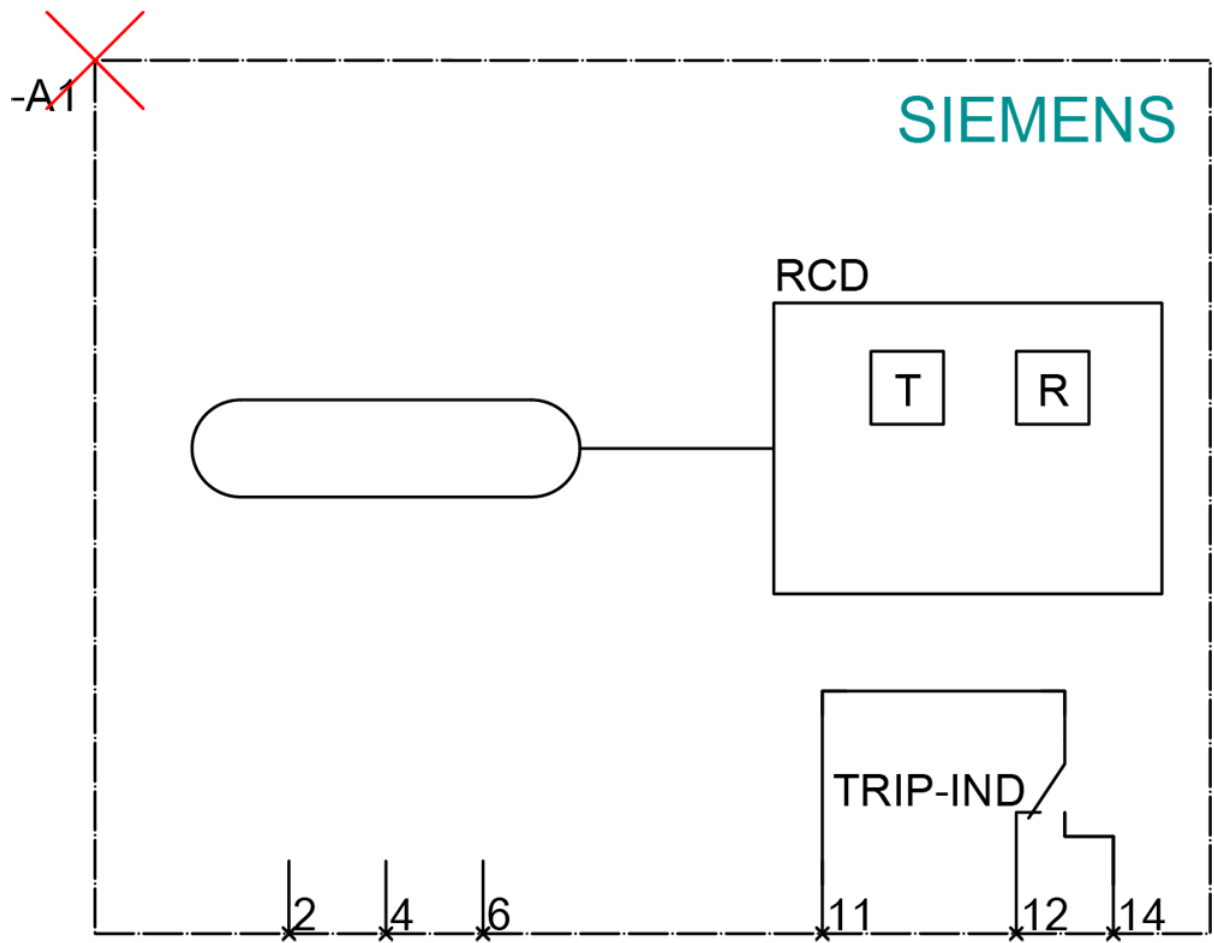

last modified:

12/20/2020